

KLT-H4MF-OV5670 V1.0**OmniVision OV5670 MIPI Interfaccia Messa a fuoco fissa 5MP Modulo telecamera**

Modulo telecamera n.	KLT-H4MF-OV5670 V1.0
Sensore d'immagine	OV5670
EFL	2.32 mm
F.NO	2.2
Pixel	2592 x 1944 (QSXGA)
Vista ad angolo	76.1°
Tipo di lente	1/5 pollice
Dimensioni dell'obiettivo	6.50 x 6.50 x 3.90 mm
Dimensione del modulo	18.50 x 12.50 mm
Tipo di modulo	Messa a fuoco fissa
Interfaccia	MIPI
Modello obiettivo IMT	IMT-3A5E005-6

Connettore di accoppiamento Codice. FH12-24S-0.5SH

Connettore di accoppiamento sulla scheda principale. Venduto separatamente.



OV5670 5-megapixel product brief



5-Megapixel PureCel® Image Sensor Brings Improved Image Quality to Rear- and Front-Facing Cameras in Mobile Devices

lead free
available in
a lead-free
package

The OV5670 is a 5-megapixel PureCel image sensor that leverages a 1.12-micron pixel to deliver exceptional still images and high-definition (HD) video to front- and rear-facing cameras in smartphones and tablets.

The OV5670 PureCel image sensor can capture full resolution 5-megapixel (2592x1944) images at 30 frames per second (fps), quad HD video at 30 fps, cropped 1080p HD at 60 fps, or 720p HD at 60 fps. When recording 720p HD video with binning, the sensor achieves sensitivity and signal-to-noise ratio that is comparable to the industry's popular 1.75-micron pixel. Additionally, the sensor's 1.12-micron pixel achieves similar full-well capacity (FWC) as the previous generation's 1.4-micron pixel.

When recording full resolution video, the OV5670 uses approximately 35 percent less power compared to OmniVision's previous generation 5-megapixel sensor. The sensor's ultra low power mode further reduces power consumption, thus minimizing battery drain.

The OV5670 fits into a compact 6 x 6 x 3.5 mm camera module, and is available in a cost-effective chip scale package (CSP).

Find out more at www.ovt.com.



Applications

- Smartphones and Feature Phones
- Tablets
- PC Multimedia
- Wearables

Product Features

- 1.12 μm x 1.12 μm pixel
- 5MP at 30 fps
- programmable controls for frame rate, mirror and flip, cropping, and windowing
- supports images sizes:
 - 5MP (2592x1944)
 - Quad HD (2560x1440)
 - 1080p (1920x1080)
 - 720p (1280x720)
 - VGA (640x480), and more
- 2k bits of embedded one-time programmable (OTP) memory for customer use
- ultra low power mode (ULPM)
- support for output formats: 10-bit RAW
- interleave row HDR output
- two-wire serial bus control (SCCB)
- MIPI serial output interface (1- or 2-lane)
- 2x binning support
- image quality control:
 - defect pixel correction
 - automatic black level calibration

OV5670



Ordering Information

- OV05670-G04A**
(color, chip probing, 200 μm backgrinding, reconstructed wafer)
- OV05670-H42A**
(color, lead-free, 42-pin CSP5)

Product Specifications

- active array size:** 2592 x 1944
- input clock frequency:** 6 - 27 MHz
- power supply:**
 - core: 1.14 - 1.26V (1.2V nominal)
 - analog: 2.6 - 3.0V (2.8V nominal)
 - I/O: 1.7 - 1.9V (1.8V nominal)
- power requirements:**
 - active: 126 mW
 - standby: 166 μW
 - XSHUTDOWN: 1 μW
- temperature range:**
 - operating: -30°C to +85°C junction temperature
 - stable image: -20°C to +60°C junction temperature
- output interfaces:** 2-lane MIPI serial output
- output formats:** 10-bit RAW RGB data
- lens size:** 1/5"
- lens chief ray angle:** 31.24° non-linear
- max S/N ratio:** 35.6 dB
- dynamic range:** 68.4 dB @ 16x gain
- maximum image transfer rate:**
 - 5MP (2592x1944): 30 fps
 - Quad HD (2560x1440): 30 fps
 - 1080p (1920x1080): 60 fps
 - 720p (1280x720): 60 fps
 - VGA (640x480): 120 fps
- sensitivity:** 490 mV/lux-sec
- pixel size:** 1.12 μm x 1.12 μm
- dark current:** 14 e⁻/sec @ 60°C junction temperature
- image area:** 2945.7 μm x 2214 μm
- package/die dimensions:**
 - CSP5: 4080 μm x 3430.2 μm
 - COB: 4050 μm x 3400.2 μm
 - RW: 4100 μm x 3450.2 μm

Functional Block Diagram

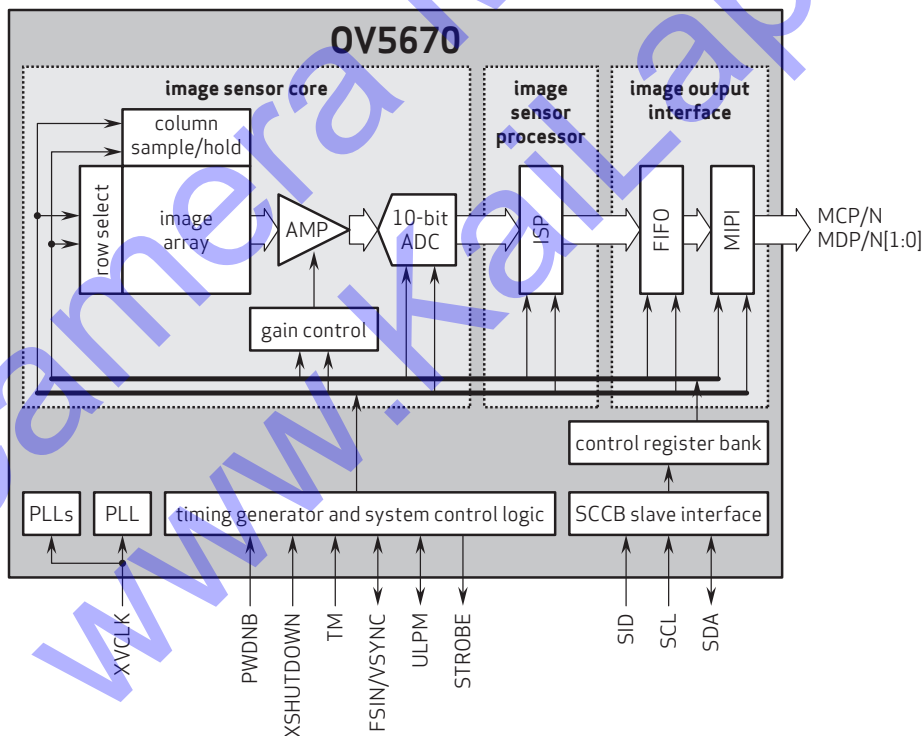

4275 Burton Drive
Santa Clara, CA 95054
USA

Tel: +1 408 567 3000
Fax: +1 408 567 3001
www.ovt.com

OmniVision reserves the right to make changes to their products or to discontinue any product or service without further notice. OmniVision, the OmniVision logo and PureCel are registered trademarks of OmniVision Technologies, Inc. All other trademarks are the property of their respective owners.



OmniVision